

# TVS Diodes

Transient Voltage Suppression Diodes

SMBJ Series



## Description

Transient Voltage Suppressor (TVS) is a circuit protection component that either attenuates (reduces) or filters a transient voltage spike (overvoltage), TVS diodes provide critical protection by going into avalanche breakdown within no more than a few nanoseconds after a strike, clamping the transient voltage, and routing its current to the ground.

## Applications

- Communication Equipment
- Security & Protection
- Industrial Control Equipment
- Power Supply
- Automotive Electronics
- New Energy
- Lightning Protection

## Functional Diagram

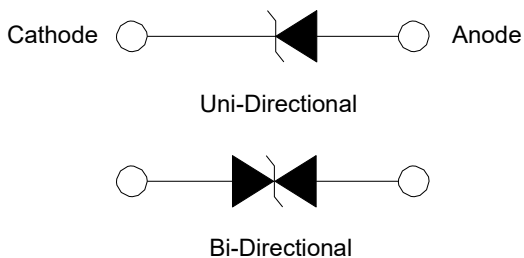

## Features

- Low incremental surge resistance
- Excellent clamping capability
- Low profile package with built-in strain relief
- Typical  $I_R$  less than 1.0  $\mu A$  above 12 V
- 600 W peak pulse power capability with a 10/1000  $\mu s$  Waveform, repetition rate (duty cycle): 0.01%
- For surface mounted applications to optimize board space
- Typical failure mode is short from over-specified voltage or current
- IEC 61000-4-2 ESD 30 kV (Air), 30 kV (Contact)
- EFT protection of data lines in accordance with IEC 61000-4-4
- Very fast response time
- Glass passivated chip junction
- High temperature to reflow soldering guaranteed: 260  $^{\circ}C/30$  sec
- $V_{BR} @ T_J = V_{BR@25^{\circ}C} \times (1 + \alpha T \times (T_J - 25))$   
( $\alpha T$ : Temperature Coefficient, typical value is 0.1%)
- Plastic package is flammability rated V-0 per Underwriters Laboratories
- Meet MSL level1, per J-STD-020
- Matte tin lead-free plated
- Halogen free and RoHS compliant
- Pb-free E3 means 2nd level interconnect is Pb-free and the terminal finish material is tin(Sn) (IPC/JEDEC J-STD-609A.01)

# TVS Diodes

Transient Voltage Suppression Diodes

SMBJ Series

## Package Outline Dimensions (DO-214AA)

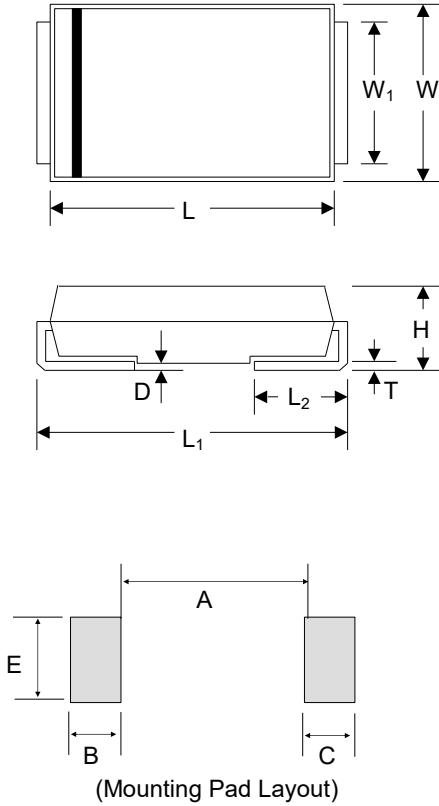

Symbol	Millimeters		Inches	
	Min.	Max.	Min.	Max.
L	4.06	4.75	0.160	0.187
W	3.30	3.94	0.130	0.155
$W_1$	1.93	2.20	0.076	0.086
H	1.99	2.61	0.078	0.103
T	0.152	0.305	0.006	0.012
$L_1$	5.21	5.59	0.205	0.220
$L_2$	0.76	1.52	0.030	0.060
D	-	0.203	-	0.008
A	-	2.74	-	0.107
B	2.16	-	0.085	-
C	2.16	-	0.085	-
E	2.26	-	0.089	-

## Maximum Ratings and Characteristics

(Ratings at 25°C ambient temperature unless otherwise specified.)

Parameter	Symbol	Value	Unit
Peak Power Dissipation with a 10/1000 $\mu$ s waveform <sup>(1)(2)</sup> (Fig.2)-Single Die Parts	P <sub>PPM</sub>	600	W
Peak Power Dissipation with a 10/1000 $\mu$ s waveform <sup>(1)(2)</sup> (Fig.2)-Stacked Die Parts <sup>(5)</sup>	P <sub>PPM</sub>	800	W
Peak Power Dissipation on Infinite Heat Sink at T <sub>L</sub> =50 °C	P <sub>D</sub>	5.0	W
Peak Forward Surge Current, 8.3 ms single half sinewave superimposed on rated load (JEDEC Method) <sup>(3)</sup>	I <sub>FSM</sub>	100	A
Maximum Instantaneous Forward Voltage at 50 A for Unidirectional Only <sup>(4)</sup>	V <sub>F</sub>	3.5 / 5.0	V
Operating Temperature Range	T <sub>J</sub>	-65 to 150	°C
Storage Temperature Range	T <sub>STG</sub>	-65 to 175	°C
Typical Thermal Resistance Junction to Lead	R <sub><math>\theta</math>JL</sub>	20	°C / W
Typical Thermal Resistance Junction to Ambient	R <sub><math>\theta</math>JA</sub>	100	°C / W

### Notes

1. Non-repetitive current pulse, per Fig. 4 and derated above T<sub>J</sub>(initial)=25 °C per Fig. 3.
2. Mounted on 5.0 mm<sup>2</sup> land areas.
3. Measured of 8.3 ms single half sine-wave or equivalent square wave, duty cycle=4 pulses per minute maximum.
4. V<sub>F</sub> < 3.5 V for single die parts and V<sub>F</sub> < 5.0 V for stacked-die parts.
5. For stacked die component details, please refer to part numbers labeled by \* in Electrical Characteristics.

# TVS Diodes

Transient Voltage Suppression Diodes

SMBJ Series

## Part Numbering System

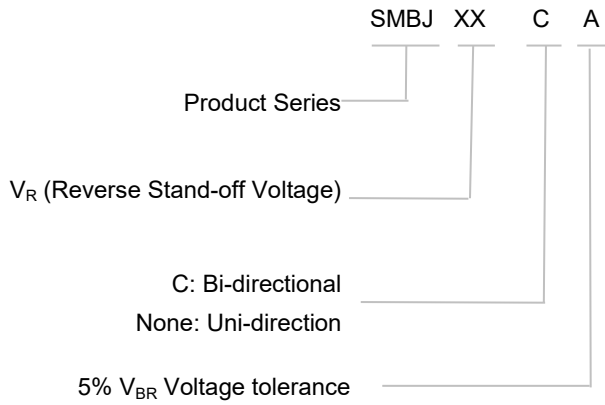

## Marking

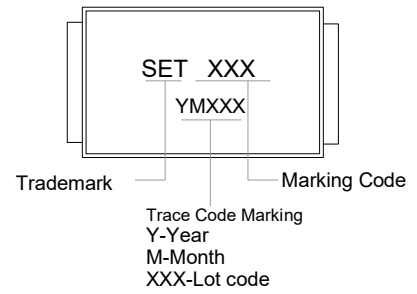
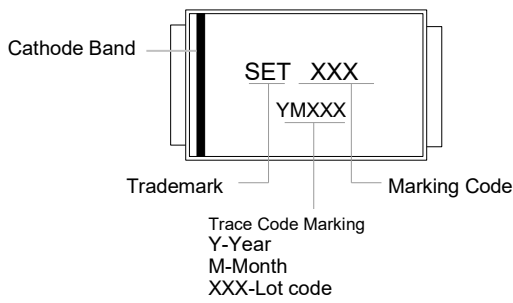

**Electrical Characteristics** ( $T_A=25\text{ }^\circ\text{C}$  unless otherwise noted )

Part Number		Device Marking Code		Breakdown Voltage $V_{BR}@I_T$		Test Current $I_T$	Reverse Stand-off Voltage $V_R$	Max. Reverse Leakage $I_R@V_R$	Max. Peak Pulse Current $I_{PPM}$	Max. Clamping Voltage $V_C@I_{PPM}$
				Min	Max					
Uni	Bi	Uni	Bi	(V)		(mA)	(V)	( $\mu\text{A}$ )	(A)	(V)
SMBJ5.0A	SMBJ5.0CA	KE	AE	6.40	7.00	10	5.00	500.00	65.30	9.20
SMBJ6.0A	SMBJ6.0CA	KG	AG	6.67	7.37	10	6.00	500.00	58.30	10.30
SMBJ6.5A	SMBJ6.5CA	KK	AK	7.22	7.98	10	6.50	300.00	53.60	11.20
SMBJ7.0A	SMBJ7.0CA	KM	AM	7.78	8.60	10	7.00	100.00	50.00	12.00
SMBJ7.5A	SMBJ7.5CA	KP	AP	8.33	9.21	1	7.50	100.00	46.60	12.90
SMBJ8.0A	SMBJ8.0CA	KR	AR	8.89	9.83	1	8.00	30.00	44.20	13.60
SMBJ8.5A	SMBJ8.5CA	KT	AT	9.44	10.40	1	8.50	20.00	41.70	14.40
SMBJ9.0A	SMBJ9.0CA	KV	AV	10.00	11.10	1	9.00	10.00	39.00	15.40
SMBJ10A	SMBJ10CA	KX	AX	11.10	12.30	1	10.00	5.00	35.30	17.00
SMBJ11A	SMBJ11CA	KZ	AZ	12.20	13.50	1	11.00	1.00	33.00	18.20
SMBJ12A	SMBJ12CA	LE	BE	13.30	14.70	1	12.00	1.00	30.20	19.90
SMBJ13A	SMBJ13CA	LG	BG	14.40	15.90	1	13.00	1.00	28.00	21.50
SMBJ14A	SMBJ14CA	LK	BK	15.60	17.20	1	14.00	1.00	25.90	23.20
SMBJ15A	SMBJ15CA	LM	BM	16.70	18.50	1	15.00	1.00	24.60	24.40
SMBJ16A	SMBJ16CA	LP	BP	17.80	19.70	1	16.00	1.00	23.10	26.00
SMBJ17A	SMBJ17CA	LR	BR	18.90	20.90	1	17.00	1.00	21.80	27.60
SMBJ18A	SMBJ18CA	LT	BT	20.00	22.10	1	18.00	1.00	20.60	29.20
SMBJ20A	SMBJ20CA	LV	BV	22.20	24.50	1	20.00	1.00	18.60	32.40
SMBJ22A	SMBJ22CA	LX	BX	24.40	26.90	1	22.00	1.00	16.90	35.50
SMBJ24A	SMBJ24CA	LZ	BZ	26.70	29.50	1	24.00	1.00	15.50	38.90
SMBJ26A	SMBJ26CA	ME	CE	28.90	31.90	1	26.00	1.00	14.30	42.10
SMBJ28A	SMBJ28CA	MG	CG	31.10	34.40	1	28.00	1.00	13.30	45.40
SMBJ30A	SMBJ30CA	MK	CK	33.30	36.80	1	30.00	1.00	12.40	48.40
SMBJ33A	SMBJ33CA	MM	CM	36.70	40.60	1	33.00	1.00	11.30	53.30
SMBJ36A	SMBJ36CA	MP	CP	40.00	44.20	1	36.00	1.00	10.40	58.10
SMBJ40A	SMBJ40CA	MR	CR	44.40	49.10	1	40.00	1.00	9.30	64.50
SMBJ43A	SMBJ43CA	MT	CT	47.80	52.80	1	43.00	1.00	8.70	69.40
SMBJ45A	SMBJ45CA	MV	CV	50.00	55.30	1	45.00	1.00	8.30	72.70
SMBJ48A	SMBJ48CA	MX	CX	53.30	58.90	1	48.00	1.00	7.80	77.40
SMBJ51A	SMBJ51CA	MZ	CZ	56.70	62.70	1	51.00	1.00	7.30	82.40
SMBJ54A	SMBJ54CA	NE	DE	60.00	66.30	1	54.00	1.00	6.90	87.10

# TVS Diodes

Transient Voltage Suppression Diodes

SMBJ Series

Part Number		Device Marking Code		Breakdown Voltage $V_{BR}@I_T$		Test Current $I_T$	Reverse Stand-off Voltage $V_R$	Max. Reverse Leakage $I_R@V_R$	Max. Peak Pulse Current $I_{PPM}$	Max. Clamping Voltage $V_C@I_{PPM}$
				Min	Max					
Uni	Bi	Uni	Bi	(V)		(mA)	(V)	( $\mu$ A)	(A)	(V)
SMBJ58A	SMBJ58CA	NG	DG	64.40	71.20	1	58.00	1.00	6.50	93.60
SMBJ60A	SMBJ60CA	NK	DK	66.70	73.70	1	60.00	1.00	6.20	96.80
SMBJ64A	SMBJ64CA	NM	DM	71.10	78.60	1	64.00	1.00	5.90	103.00
SMBJ70A	SMBJ70CA	NP	DP	77.80	86.00	1	70.00	1.00	5.30	113.00
SMBJ75A	SMBJ75CA	NR	DR	83.30	92.10	1	75.00	1.00	5.00	121.00
SMBJ78A	SMBJ78CA	NT	DT	86.70	95.80	1	78.00	1.00	4.80	126.00
SMBJ85A	SMBJ85CA	NV	DV	94.40	104.00	1	85.00	1.00	4.40	137.00
SMBJ90A	SMBJ90CA	NX	DX	100.00	111.00	1	90.00	1.00	4.10	146.00
SMBJ100A	SMBJ100CA	NZ	DZ	111.00	123.00	1	100.00	1.00	3.70	162.00
SMBJ110A	SMBJ110CA	PE	EE	122.00	135.00	1	110.00	1.00	3.40	177.00
SMBJ120A	SMBJ120CA	PG	EG	133.00	147.00	1	120.00	1.00	3.10	193.00
SMBJ130A	SMBJ130CA	PK	EK	144.00	159.00	1	130.00	1.00	2.90	209.00
SMBJ150A	SMBJ150CA	PM	EM	167.00	185.00	1	150.00	1.00	2.50	243.00
SMBJ160A	SMBJ160CA	PP	EP	178.00	197.00	1	160.00	1.00	2.30	259.00
SMBJ170A	SMBJ170CA	PR	ER	189.00	209.00	1	170.00	1.00	2.20	275.00
SMBJ180A	SMBJ180CA	PT	ET	201.00	222.00	1	180.00	1.00	2.10	292.00
SMBJ188A	SMBJ188CA	PB	EB	209.00	231.00	1	188.00	1.00	2.00	304.00
SMBJ200A	SMBJ200CA	PV	EV	224.00	247.00	1	200.00	1.00	1.90	324.00
SMBJ220A	SMBJ220CA	PX	EX	246.00	272.00	1	220.00	1.00	1.70	356.00
SMBJ250A	SMBJ250CA	PZ	EZ	279.00	309.00	1	250.00	1.00	1.50	405.00
SMBJ300A*	SMBJ300CA*	QE	FE	335.00	371.00	1	300.00	1.00	1.30	486.00
SMBJ350A*	SMBJ350CA*	QG	FG	391.00	432.00	1	350.00	1.00	1.10	567.00
SMBJ400A*	SMBJ400CA*	QK	FK	447.00	494.00	1	400.00	1.00	0.90	648.00
SMBJ440A*	SMBJ440CA*	QM	FM	492.00	543.00	1	440.00	1.00	0.90	713.00

Notes:

1. For bidirectional type having  $V_R$  of 10 volts and less, the  $I_R$  should be doubled.
2. For parts without A in the PN, the  $V_{BR}$  tolerance is  $\pm 10\%$  and  $V_C$  is 5% higher than parts with A. The parts without A are currently available, but not recommended for new designs. The parts with A are preferred.
3. For stacked die component details, please refer to models marked with \* in electrical characteristics table.

# TVS Diodes

Transient Voltage Suppression Diodes

SMBJ Series

## I-V Curve Characteristics

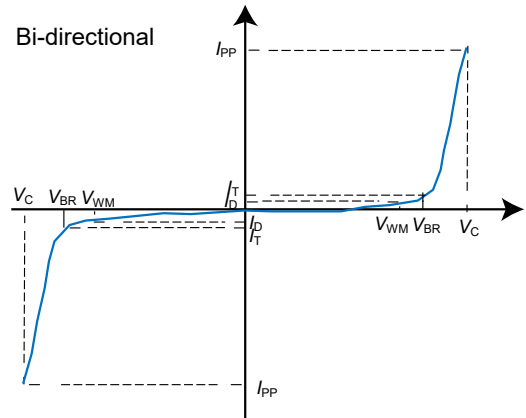
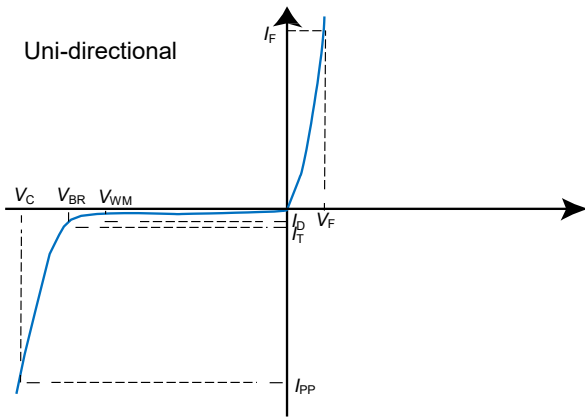

## Performance Curve for Reference ( $T_A=25^\circ\text{C}$ unless otherwise noted)

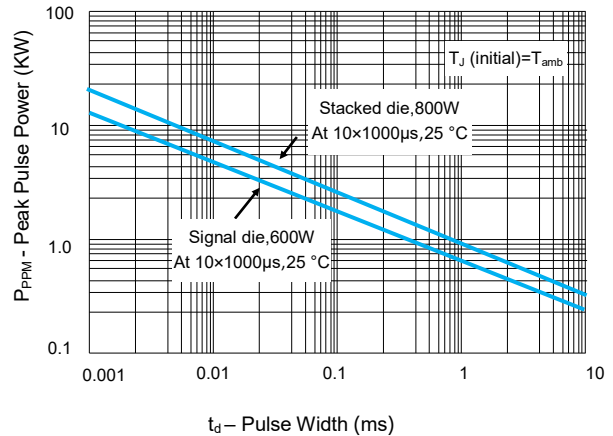
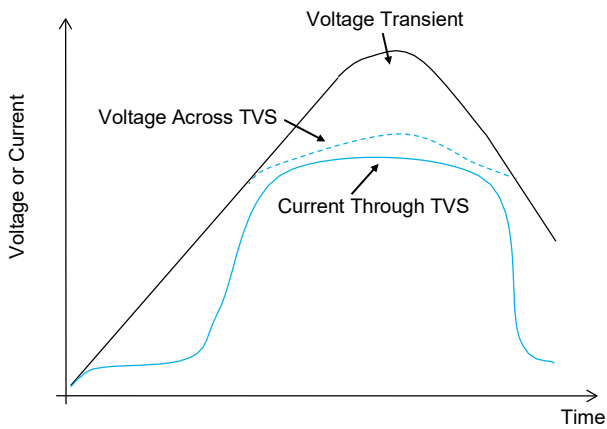

FIGURE 1 TVS Transients Clamping Waveform

FIGURE 2 Peak Pulse Power Rating Curve

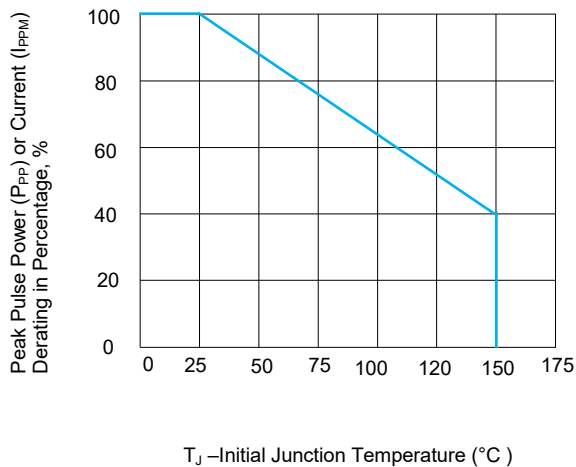

FIGURE 3 Peak Pulse Power Derating Curve

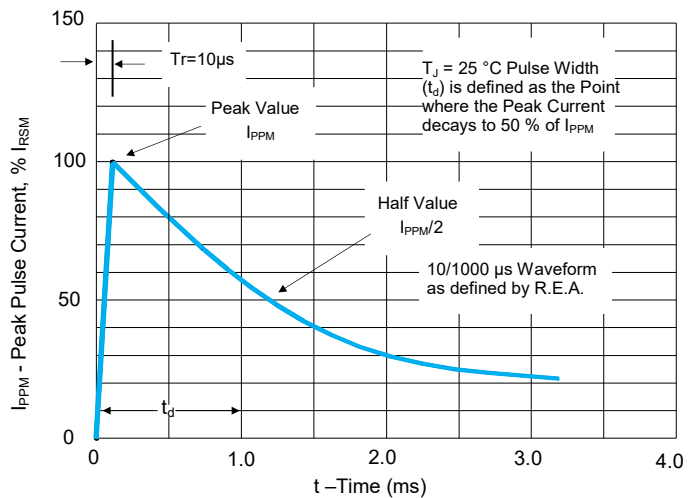

FIGURE 4 Pulse Waveform

# TVS Diodes

Transient Voltage Suppression Diodes

SMBJ Series

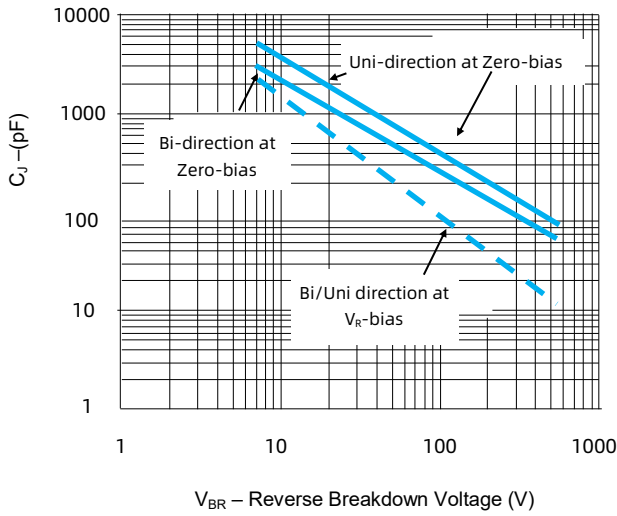

FIGURE 5 Typical Junction Capacitance

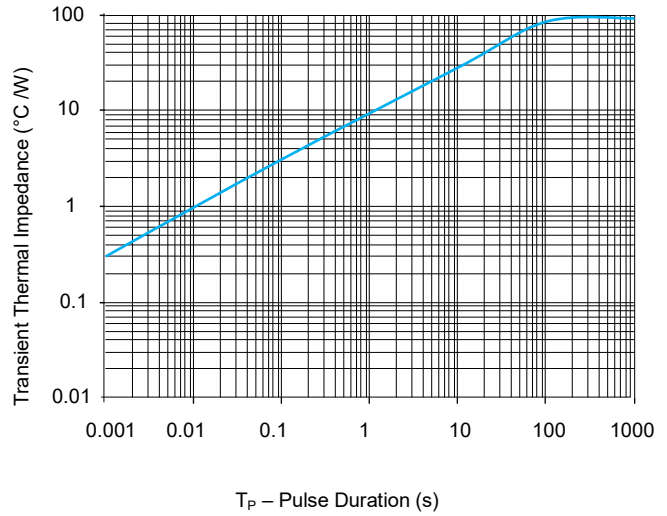

FIGURE 6 Typical Transient Thermal Impedance

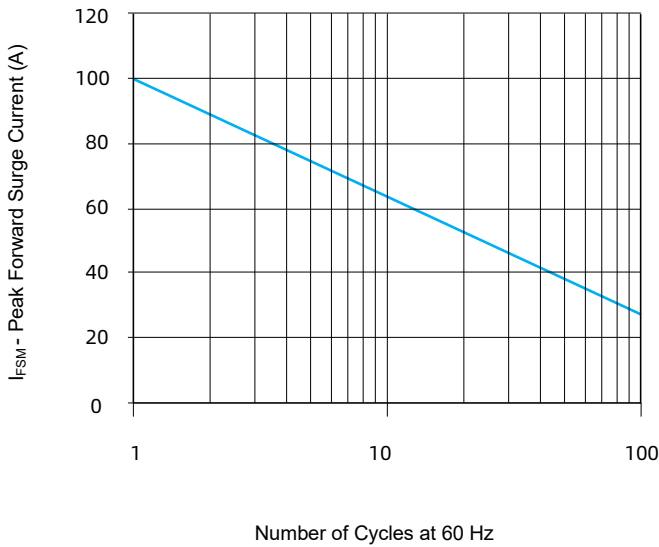

FIGURE 7 Maximum Non-Repetitive Forward Surge Current Uni-Directional only

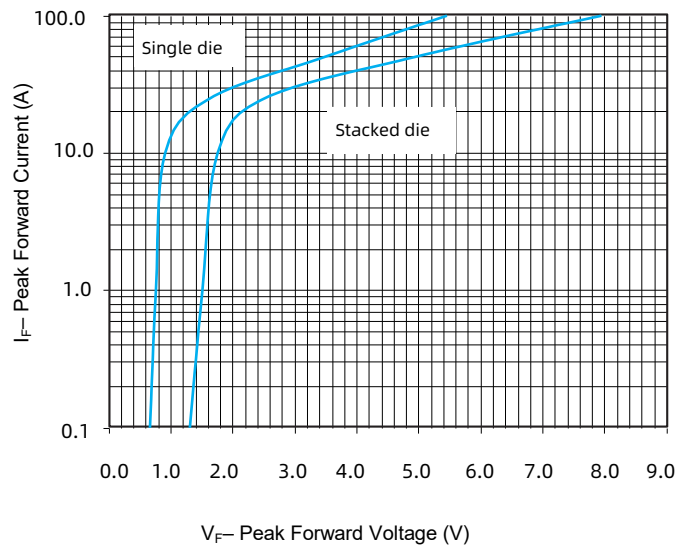

FIGURE 8 Peak Forward Drop vs Peak Forward Current (Typical Values)

## Environmental Specifications

High Temp. Storage	JESD22-A103
HTRB	JESD22-A108
Temperature Cycling	JESD22-A104
MSL	JESDEC-J-STD-020, Level 1
H3TRB	JESD22-A101
RSH	JESD22-A111

## Physical Specifications

Weight	0.003 ounce, 0.093 grams
Case	JESD22DO214AA. Molded plastic body over glass passivated junction
Polarity	Color band denotes positive end (cathode) except Bidirectional
Terminal	Matte Tin-plated leads, Solderability per JESD22-B102



Soldering Parameters

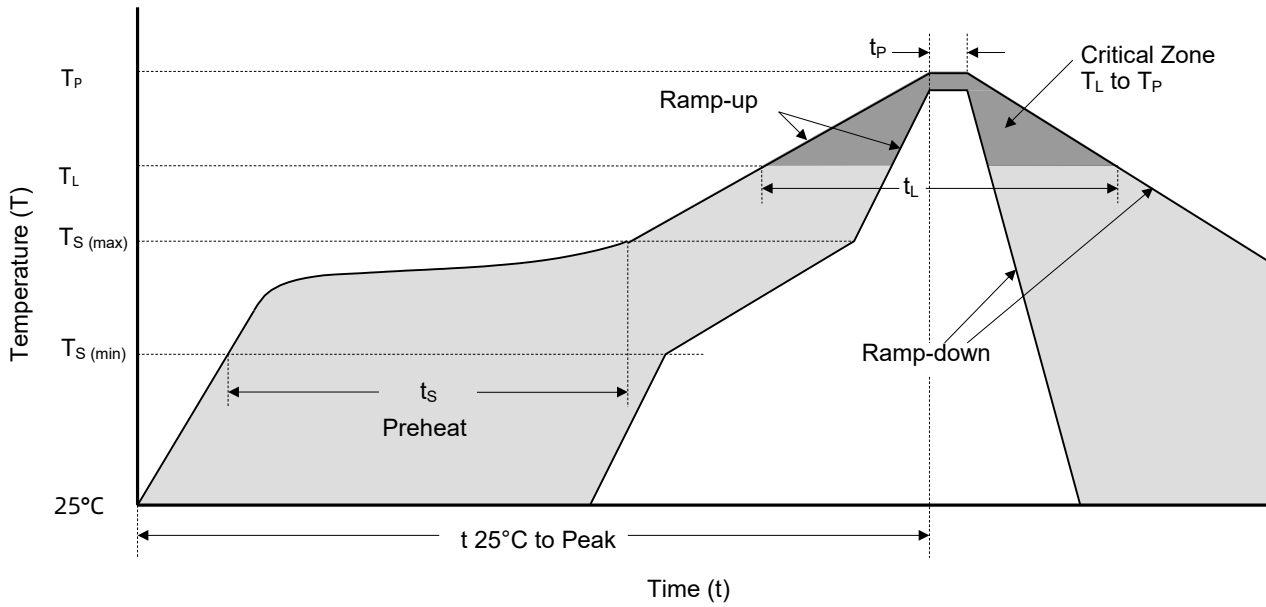

Reflowing Condition

Reflow Soldering Parameters		Lead-Free Assembly
Pre-heat	Temperature Min ( $T_{S (min)}$ )	150 °C
	Temperature Max ( $T_{S (max)}$ )	200 °C
	Time (min to max) ( $t_s$ )	60 ~ 120 seconds
Average Ramp Up Rate (Liquidus Temp ( $T_L$ ) to Peak)		3 °C / second max.
$T_{S (max)}$ to $T_L$ Ramp-up Rate		3 °C / second max.
Reflow	Temperature ( $T_L$ ) (Liquidus)	217 °C
	Time (min to max) ( $t_L$ )	60 ~ 150 seconds
Peak Temperature ( $T_P$ )		260 <sup>+0/-5</sup> °C
Time of within 5 °C of Actual Peak Temperature ( $t_p$ )		20 ~ 40 seconds
Ramp-down Rate		6 °C / second max.
Time from 25 °C to Peak Temperature		8 Minutes max.
Do Not Exceed		260 °C

# TVS Diodes

Transient Voltage Suppression Diodes

SMBJ Series

## Packaging Information

Tape	Symbol	Dimension (mm)
	W	12.00+0.30/-0.10
	P <sub>0</sub>	4.00±0.10
	P <sub>1</sub>	8.00±0.10
	P <sub>2</sub>	2.00±0.05
	D <sub>0</sub>	1.55±0.05
	D <sub>1</sub>	1.55±0.05
	E	1.75±0.1
	F	5.50±0.05
	A <sub>0</sub>	3.78±0.10
	B <sub>0</sub>	5.65±0.15
	K <sub>0</sub>	2.70±0.10
	T	0.30±0.05

Reel Size	13" Reel	
	A	330 mm
	C	13.2 mm
	W <sub>1</sub>	12.5 mm

Part Number	Package	QTY (Reel)	Packaging Option	Packaging Specification
SMBJxxx	DO-214AA	3000 PCS	Tape & Reel – 12 mm tape/13" reel	EIA STD RS-481

## Glossary

Item	Description
$V_C$	<b>Clamping Voltage</b> Voltage across TVS in a region of low differential resistance that serves to limit the voltage across the device terminals.
$V_R$	<b>Reverse Stand-off Voltage</b> Maximum voltage that can be applied to the TVS without operation. NOTE : It is also shown as $V_{WM}$ (maximum working voltage (maximum d.c. voltage)) and known as rated stand-off voltage ( $V_{so}$ ).
$I_R$	<b>Reverse Leakage Current</b> Current measured at $V_R$ . NOTE : Also shown as $I_D$ for stand-by current.
$V_{BR}$	<b>Breakdown Voltage</b> Voltage across TVS at a specified current $I_T$ in the breakdown region.
$I_{PPM}$	<b>Rated Random Recurring Peak Impulse Current</b> Maximum-rated value of random recurring peak impulse current that may be applied to a device.
$P_{M(AV)}$	<b>Rated Average Power Dissipation</b> Maximum-rated value of power dissipation resulting from all sources, including transients and standby current, averaged over a short period of time.
$P_{PPM}$	<b>Rated Random Recurring Peak Impulse Power Dissipation</b> Maximum-rated value of the product of rated random recurring peak impulse current ( $I_{PPM}$ ) multiplies by specified maximum clamping voltage ( $V_C$ ).
$C_J$	<b>Capacitance</b> Capacitance across the TVS measured at a specified frequency and voltage.
$V_{FS}$	<b>Peak Forward Surge Voltage</b> Peak voltage across an TVS for a specified forward surge current ( $I_{FS}$ ) and time duration. NOTE : Also shown as $V_F$ .
$I_{FS}$	<b>Forward Surge Current</b> Pulsed current through TVS in the forward conducting region. NOTE : Also shown as $I_F$ .
$\alpha_{V(BR)}$	<b>Temperature Coefficient of Breakdown Voltage</b> The change of breakdown voltage divided by the change of temperature.
$I_{PP}$	<b>Peak pulse Current</b> Peak pulse current value applied across the TVS to determine the clamping voltage $V_C$ for a specified wave shape.
$I_T$	<b>Pulsed D.C. Test Current</b> Test current for measurement of the breakdown voltage $V_{BR}$ . This is defined by the manufacturer and usually given in milliamperes with a pulse duration of less than 40 ms. NOTE : Also shown as $I_{BR}$ .

—(GB-T 18802.321 / IEC 61643-321 / JESD210A)



# ATTENTION

## Usage

1. TVS must be operated in the specified ambient temp.
2. Do not clean the TVS with strong polar solvent such as ketone, esters, benzene and halogenated hydrocarbon, to avoid damaging the encapsulating layer.
3. Please do not apply severe vibration, shock or pressure to TVS, to avoid element cracking.

## Replacement

1. If TVS is visually damaged, please replace it.
2. TVS is a non-repairable product. For safety sake, please use equivalent TVS for replacement.

## Storage

1. Storage Temp. Range: (-55 to 150) °C.
2. Do not store the TVS at the high temp., high humidity or corrosive gas environment, to avoid influencing the solder- ability of the lead wires. The product shall be used up within 1 year after receiving the goods.

## Environmental Conditions

1. TVS should not be exposed to the open air, nor direct sunshine.
2. TVS should avoid rain, water vapor or other condition of high temp. and high humidity.
3. TVS should avoid sand dust, salt mist, or other harmful gases.

## Max. Typical Capacitance of TVS

The typical capacitance of TVS is listed in the specifications. Designers may refer to it when designing TVS in High frequency circuit.

## Installation Mechanical Stress

1. Do not knock TVS when installing, to avoid mechanical damage.
2. Please do not apply severe vibration, shock or pressure to TVS, to avoid surface resin or element cracking.

## Transient Voltage Suppressor ( Surface Mount ) Features Overview

Package Type	DO-221AC	DO-214AA	DO-214AB	DO-214AC	SOD-123FL	SMT0-218	Series	
	○	○	○	○	○	○	SMA6L	
	○	○	○	○	○	○	SACB	
	○	○	○	○	○	○	SMBJ	
	○	○	○	○	○	○	P6SMB	
	○	○	○	○	○	○	SMAJ	
	○	○	○	○	○	○	P4SMA	
	○	○	○	○	○	○	SMA6J	
	○	○	○	○	○	○		
	○	○	○	○	○	○		
	○	○	○	○	○	○		
	○	○	○	○	○	○		
<b>Product Outline (mm)</b>								
<b><math>V_R / V_{WM}</math> (V)</b> Reverse Stand-off Voltage	5.0 ~ 250	5.0 ~ 85	5.0 ~ 440	5.8 ~ 468	5.0 ~ 250	5.0 ~ 50	5.0 ~ 440	5.8 ~ 512
<b><math>P_{PPM}</math> (W)</b> <b>(10/1000 <math>\mu</math>s)</b> Rated Peak ImPulse Power Dissipation	200		400		600	500	600	
<b><math>I_{PPM}</math> (kA)</b> <b>(8/20 <math>\mu</math>s)</b> Rated Peak ImPulse Current							○	
<b>Operating Temperature (°C)</b>	-55 to +150							

**Transient Voltage Suppressor ( Surface Mount ) Features Overview**

Package Type	Series									
	DO-221AC	DO-214AA	DO-214AB	DO-214AC	SOD-123FL	SMT0-218	SPC1	SPC3	SPC6	SPC10
	○	○	○	○	○	○	○	○	○	○
	○	○	○	○	○	○	○	○	○	○
	SMCJ	1.5SMC	3.0SMCJ	SMDJ	5.0SMDJ	○	○	○	○	○
	○	○	○	○	○	○	○	○	○	○
	○	○	○	○	○	○	○	○	○	○
	○	○	○	○	○	○	SPC1	SPC3	SPC6	SPC10
Product Outline (mm)										
$V_R / V_{WM}$ (V) Reverse Stand-off Voltage	5.0 ~ 440	5.8 ~ 512	5.0 ~ 440		12 ~ 170	380 / 430	66	58 ~ 76	58 ~ 86	
$P_{PPM}$ (W) (10/1000 $\mu$ s) Rated Peak ImPulse Power Dissipation	1500		3000		5000	○				
$I_{PPM}$ (kA)(8/20 $\mu$ s) Rated Peak ImPulse Current	○		○		○		1	3	6	10
Operating Temperature (°C)	-55 to +150					-55 to +125				

## Transient Voltage Suppressor ( Axial Lead ) Features Overview

Package Type	Series																	
	DO-201	DO-41	DO-15	P600	Radial lead	1.5KE	LCE	5KP	15KPA	20KPA	30KPA	SPCL1	SPCL3	SPCL6	SPCL10	SPCL15	SPCL20	
Product Outline (mm)																		
$V_R / V_{WM}$ (V) Reverse Stand-off Voltage	5.8 ~ 468	5.0 ~ 50	5.8 ~ 512	5.8 ~ 512	6.5 ~ 90	5.0 ~ 250	17 ~ 280	20 ~ 300	28 ~ 360	76	15 ~ 430	30 ~ 430	15 ~ 530	58 ~ 380	16 ~ 76			
$P_{PPM}$ (W) (10/1000 $\mu$ s) Rated Peak ImPulse Power Dissipation	400	500	600	1500	5000	15000	20000	30000										
$I_{PPM}$ (kA)(8/20 $\mu$ s) Rated Peak ImPulse Current												1	3	6	10	15	20	
Operating Temperature (°C)						-55 to +150						-55 to +125						